



# The G-QRP Club



## The Limerick Sudden 80m Receiver Kit



**Circuit design – George Dobbs G3RJV**  
**PCB design – Rex Harper W1REX**  
**Kit parts spec and purchase – Graham Firth G3MFJ**  
**Manual – G3RJV and G3MFJ**



# The G-QRP Club



Founded in 1974, the G-QRP Club is the largest QRP Club in the world. The club exists to promote interest and growth in low power amateur radio communication (5 watts or less). Membership is open to any licensed radio amateur or short wave listener anywhere in the world.

The club publishes a quarterly journal called SPRAT, which is sent free to members. SPRAT contains many circuits, technical hints and ideas for QRP construction projects, together with club news, contest and award information and other items of interest to QRP operators. SPRAT is an exclusive QRP journal and contains much practical information in each issue. The club operates a club sales department where components are available at special prices to club members. We also publish QRP books which are available to members.

If you are not a member, and would like to find out more, please look at [www.gqrp.com](http://www.gqrp.com). For a sample SPRAT and a membership form, please send your name and address to our membership secretary:

Daphne Newsum G7ENA, 33 Swallow Drive, Louth, LN11 0DN  
[membership@gqrp.co.uk](mailto:membership@gqrp.co.uk)

Please mention where you saw this information

## Background

The Limerick Sudden is built around two integrated circuit chips; the SA602\* and the LM386. Both lend themselves to simple receiver construction; although neither has particularly high performance in that application. Having said that, the Sudden is a remarkable receiver for what it contains. It covers the full UK 80m ham band and receives CW and SSB very well.

The original Sudden began life over 20 years ago in SPRAT and was then published in Practical Wireless followed by the "73" magazine in the U.S.A. Since then several versions and modifications to the Sudden receiver have been written up; although very few of them were written by me. The original naming of the "Sudden" had nothing to do with "rapidity" or "hastiness" but was taken from the name of the place where I lived and worked. The SPRAT version was available as a kit from Kanga Products. The kit proved very popular with beginners and several groups used it as a training project with young people. There was even a surface mount version; produced for a while by Blue Rose Electronics. In more recent times a version of the receiver was packaged in a tuna tin on a circular printed circuit board and called "The Sudden Storm" by W1REX at qrpme.com.

## The Circuit

The Sudden has only two active components: IC1, an SA602\* chip which contains a mixer and an oscillator and IC2, an LM386 audio amplifier chip. The signal at the antenna input goes directly to an attenuator; a 10K linear potentiometer that serves as the receiver GAIN control. The required signals are selected by a two stage band-pass filter. There are two tuned circuits L1/C1 and L2/C3 loosely coupled by C2. Note that the tuned windings of L1 and L2 have a centre tap connection that is not used. Only the two outer connections are used. The link winding of L1 receives the signals from the gain control but the link winding of L2 is unused, the output being taken from across the tuned winding. The output from the band-pass filter goes to the input of the mixer at pins 1 and 2 of IC1.

IC1 contains an internal oscillator circuit that is accessed via pins 6 and 7. This is a version of the Colpitts oscillator; the frequency of which is determined by L3 and its associated capacitors and adjusted by the 60pF Tuning Capacitor. The oscillator is tuned across the required amateur band. The mixer section of IC1 mixes the signals from the band-pass filter and the signal from the oscillator and the resulting signals appear at pins 4 and 5. An audio (sound) output will appear at the upper and lower sidebands of the oscillator frequency. These are the signals we require.

The required audio signals are fed to IC2 via C6 and C7; this uses the balanced input to the LM386. C15 between pins 1 and 8 of IC2 (the gain control pins) gives the maximum voltage gain of about 45dB. The output appears at pin 5 and is fed to the output jack via C18. C16 and R3 form a filter (called a zobel network) to aid amplifier stability. The output of the LM386 is about 350 milli-watts. This will drive a small loudspeaker although it works better with "walkman-type" headphones.

\* Whilst the SA602 designation is used throughout this manual, your kit may contain an NE602, an NE612, or an SA612. All the electronics are identical – the differences (if any), are either cosmetic or the package construction material.

## Building your kit

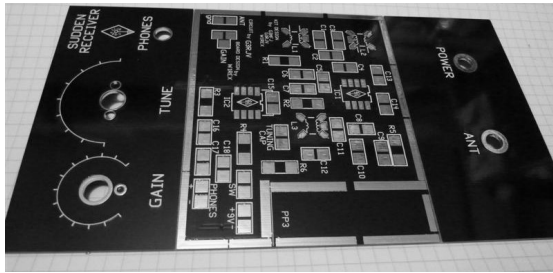

You will have noticed that this is a rather unusual kit. It has a printed circuit board without any holes. We call it “Limerick Construction” because it was designed by Rex Harper, W1REX, of Limerick, Maine. It is a surface mounted board in that the components are mounted on the surface of the board, although the components used

are “through-hole” parts. This allows for ease of construction and easy correction of any errors. The main board also has the front and back panels for the receiver. They are scored and can be snapped off the main board. We suggest you smooth the snapped edges with emery paper or an emery board.

The component parts are soldered to the top surface of the board using the leads that would go through the board on a conventional printed circuit board. The interconnections between the mounting pads are ready made but hidden by the black screen printed overlay. The designation of all the parts is printed next to the appropriate pads.

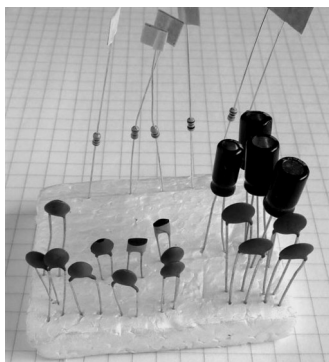
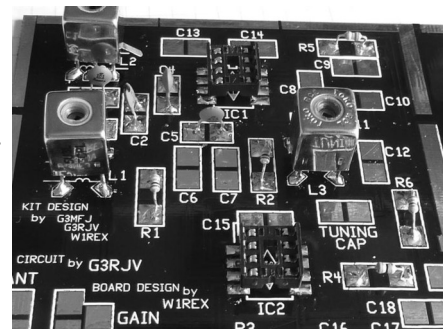

There is merit in following this order in construction. Note that the instructions refer to having the board so that the legends for the components read the correct way round (PP3 at the top right). The best results will come from the use of medium size soldering iron and Tin/Lead solder. It does help to set out all the components in the order they will be used. The best way is to use a small piece of polystyrene to hold the individual parts.

### Mount the IC holders first.

Bend the pins of the IC holder to be flush with the base of the holder; splayed out either side of the body of the holder. Tin (add a solder layer) to each pin.

Notice that there is an indentation between pins 1 and 8. (Pin 1 is on the left, pin 8 on the right). This indentation also occurs on the IC holder. This shows the correct way to connect the IC.

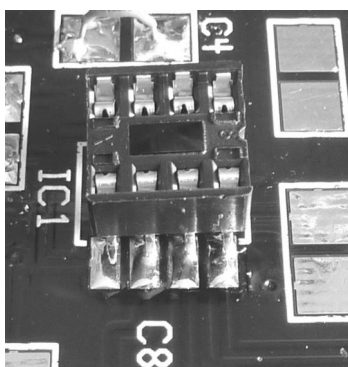

Tin the pads for IC1 and IC2.

Place the IC holder over the pads so that the pins rest on the appropriate pads. Using the soldering iron, plus a little solder, secure the IC holder at pin 8 (top right). Check that the IC holder is properly aligned and secure pin 4 (diagonally opposite to pin 8). Then secure each of the 8 pins by applying the iron and a little more solder. At this point it may be helpful to check the continuity of the connections by using a multimeter set on the lowest “ohms” range with the probes between the top connections on the IC holder and the appropriate pad.

This is probably the most difficult soldering job .... It is all down hill from this point!

### Mount the coils

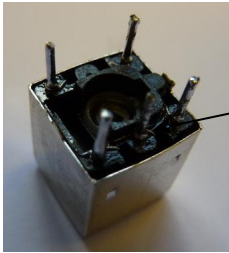

The oscillator coil, L3, is a 5u3L component, and the bandpass filter coils, L1 and L2, are 45u0L components.

The coils have a solder lug on each side as part of the screened can. Bend these out 90 degrees and cut them off. Tin the leads of all 5 pins on the coil – a nice blob of solder on each one. Tin the 5 pads for each coil (L1, L2 and L3). Note that the side of the coil with 3 connections has the pads mounted closely, so avoid using excessive solder and bridging the gaps between these pins. Seat the coil pins (do not bend them) over the pads and secure one of the pins with a little solder and the hot tip of the soldering iron. Check that the other pins align with the pads and solder each of the pins to the pads. Closely inspect the 3 pin side of each coil for accidental solder bridges.

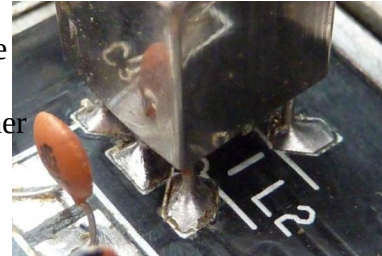

### Mount the passive components

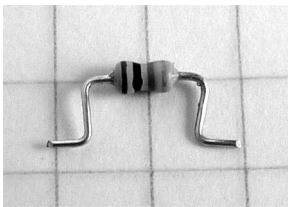

The passive components (resistors and capacitors) can now be added.

Begin with the resistors (R1 to R6). The colour code for the resistors is given in the parts list. To enable a secure solder connection of the parts, the leads are bent into an “L” shape for adding to the pads on the board.

The bent out portion of the lead forms a foot for soldering to the pad. Tin each “foot” and each pad and firmly solder the component into place

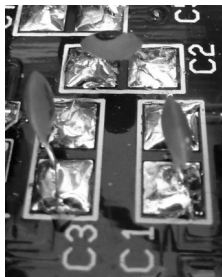
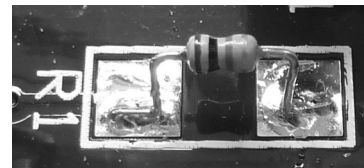

The capacitors (C1 to C18) can now be mounted; trimming and bending the leads for soldering to the pads. The value designation for each capacitor is shown in the parts list. Check carefully that the correct capacitor is chosen for each place.

There are four electrolytic capacitors (C14, C15, C17, and C18). These capacitors are polarised and must be connected the correct way round on the pads. A stripe down one side of the capacitor case with dashed lines, indicates the **negative** side of the capacitor. Looking at the board with the parts markings the correct way up (PP3 on the right hand side) C14, C15, C17 and C18 all have the **negative (striped side) connected to the right hand pad**. The components are all now mounted on the board so this is a good time to inspect the connections to check that all the solder joints are clean and firm.



### Add the side cheeks

This is also a good time to solder the “side cheeks” into place either side of the main board. These are designed as fixing plate for the enclosure. Be careful to get these the correct way round—the holes are not equally spaced from the ends. They should be placed so that the holes are nearer the front panel—this lets the case overhang at the front to give a hooded effect.

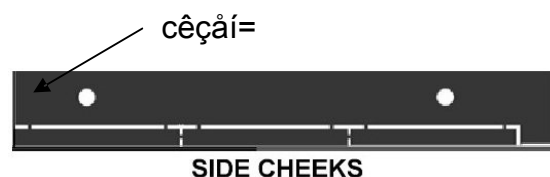

Adding the side cheeks at this point does mean that the fixing of the front and back panels of the receiver is much easier. Attaching the side cheeks does require a really hot soldering iron bit and plenty of solder. The side cheeks should be soldered on top of the main board and we suggest that you begin with a large blob of solder at each end to fix the position. Attempt to get the side cheek as near vertical as possible. You may freely run more solder along the narrow pads on the length of the board.

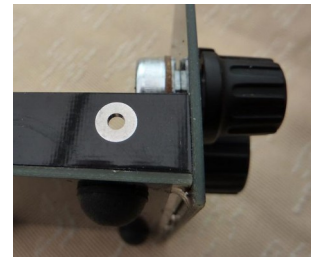

**The front panel**

The front panel holds the tuning capacitor, the gain control potentiometer and the phones socket. Like the side cheeks it is soldered to the main board. The panel should be soldered underneath as well as on top for extra strength.

**The gain control**

The gain control potentiometer needs to be prepared by cutting it down to about 1 cm long so that the knob can seat close to the front panel. This can be done with a small hacksaw.

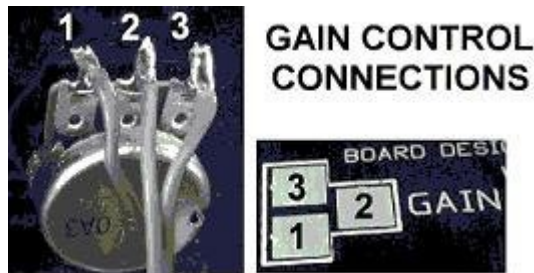
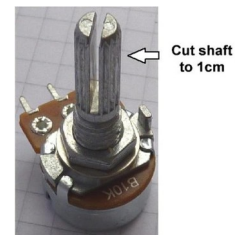

The gain potentiometer connections are shown; numbered 1, 2 and 3.

**The tuning capacitor**

The tuning capacitor is a two section polyvaricon type but only the section with the smallest capacitance is used. There are markings (rather small) to indicate the capacitance of each section. A = 140pF, O = 60pF and G = Ground. We only require the O and G connections. The "A" solder tag can be removed to avoid confusion.

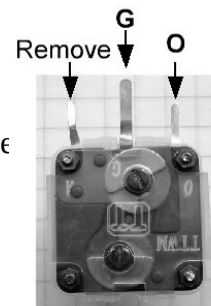

The connections to the pads on the board are shown here. The capacitor should be mounted tags downwards — this makes the connections shorter. If you get the connections reversed, the receiver will still work, but there will be a change of frequency as your hand approaches the tuning control.

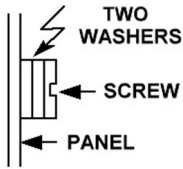

### Important!

The tuning capacitor is mounted to the front panel using two small screws. These both require two washers, between the screw and the panel, to prevent the screws touching the capacitor plates. Later versions of the kit have shorter screws so washers are not needed.

### The phones socket

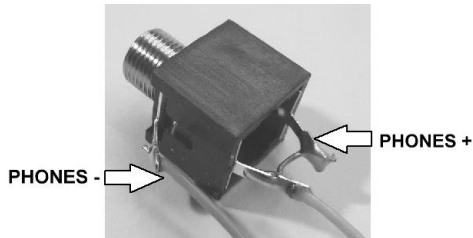

To enable a pair of “walkman-type” headphones to be used with the receiver the phones socket must be connected as shown. The two connectors at the back of the socket are joined and connected to the **PHONES +** pad and the connector at the front is connected to the **PHONES -** pad. We suggest that you connect the wires to the socket first, cut them to

length (3 to 4cm) and then solder the other ends to the board before fixing the socket to the front panel as space is a little tight here.

### The back panel

The back panel contains the antenna input socket and the power on-off switch. Like the front panel it is soldered to the main board. Again, remember to solder it underneath as well as on top. Now might be a good time to stick the self adhesive feet under the base.

### The antenna input socket

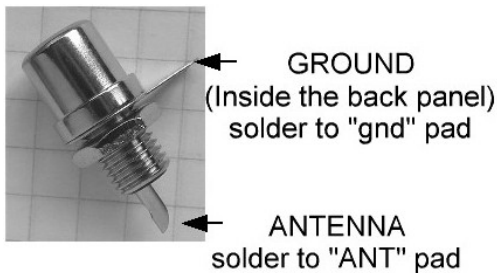

The antenna input socket is a single hole fixing ‘phono socket’. It has a ground connection tag that needs to be inside the back panel. Bend this tag inwards for a wire that connects to the “gnd” pad. The antenna input connection is soldered to the “ANT” pad. Use differing colours to identify the two leads and twist them together.

### The power switch

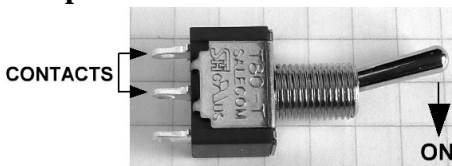

The power switch enables the PP3 battery to be switched on and off. When the switch level is in the down position, the two contacts marked here will be joined. Use two wires to connect these contacts to the **SW** pads (either way round).

Cut the leads on the PP3 battery snap on connector to about 4 – 5 cm and connect them to the **9V** pads; red to +, black to -.

### Adding the ICs

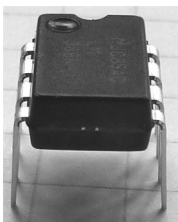

Before pushing the ICs into the holders, the pins need to be pushed slightly inwards. The easiest way to do this is to lay the IC pins (one side at a time) against a flat surface and gently push them very slightly inwards until both rows of pins are parallel and they line up with the holes in the sockets. Push them into place very gently. They must be mounted the correct way round in the holder. The end with the indentation (and the dot at pin 1) goes to the end with the indentation on the board placement markings. This is towards the back of the board in both cases.

The wiring of the receiver is now complete so you may want to check the board for correct placements and good solder joints before applying power.

## Setting Up the Receiver Oscillator

Ideally a frequency counter, a signal generator, or even another receiver that covers the same frequency may be used to set up your Sudden. For those without these items of test equipment, it is quite possible to set it up “by ear”.

- Using a frequency counter to set up the receiver oscillator.

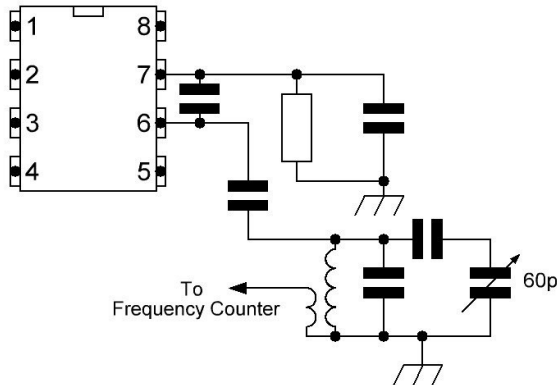

L3, the oscillator coil, has an unused link winding. This may be used to feed a frequency counter. Connect one (either) side of the link winding to ground and use the other end to connect to the counter. Some counters may detune the frequency a little so putting a low value capacitor (47 to 100pF) between the counter and the link winding is advised. Set the Tuning Capacitor control fully anti-clockwise and adjust the core to

read a frequency just below 3.5 MHz. Be warned! Rough use of the adjustable core can break it. Ideally use a proper “trimming tool” in the slot on the core. If a trimming tool is not available you could file a screwdriver blade shape on a thin knitting needle or even a cocktail stick. If you must use a small screwdriver... do it with great care as the cores are very brittle. Take care not to screw the core right through the coil as you will have to remove the coil to get it back into the coil!



- Using a signal generator to set up the receiver oscillator.

Set the signal generator on 3.5 MHz and feed the signal into the antenna input. Begin with a low output from the signal generator and only increase the output if it cannot be detected by the receiver. Set the Tuning Capacitor control almost fully anti-clockwise and gently rotate the core of L3 until the generator signal is heard.

- Setting the oscillator frequency by ear

Connect an antenna to the receiver input (a decent antenna is helpful) and set the Tuning Capacitor nearly anti-clockwise. Adjust the core of L3 until CW (Morse) signals on the 3.5 MHz band can be heard. A good starting point is with the core 1 complete turn downwards from when it is flush with the top of the former. The strength of the signals will depend upon the time of day. It will require some experimentation to find the low end of the band. Try to find the lowest frequency CW signal.

- Setting the oscillator frequency with another receiver

If you place the antenna lead of the other receiver near to your Sudden, then you can look for the VFO as a steady carrier signal. If the tuning dial is fully counter-clockwise, the signal should be just under 3.5 MHz. You should adjust the core of L3 until you hear the signal. Again, the tool you are using to adjust the core may affect the frequency.

The receiver will easily cover the whole of the 3.5 MHz amateur band, plus a little extra on either side.



## Setting up the input filter

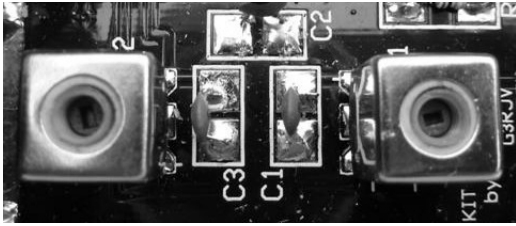

The two input tuned circuits L1/C1 and L2/C3 are set to maximum output using the cores in L1 and L2. Use a trimming tool or work very carefully with a small slotted screwdriver. L1 and L2 can be peaked for maximum signal strength using a signal generator or amateur

band signals. Even if using a signal generator it is an advantage to do a final adjustment listening to band signals; these are what we will be using the receiver for. Use the best available antenna for these adjustments. Adjust L1 first for a peak in the signals and then adjust L2. Repeat this several times until the best results are obtained. Again, take care not to screw either core right through its coil!

The position of the core will vary with individual receivers because of the tolerance of C1 and C3 and the nominal inductance of individual coils. Usually the input filter will peak with the core set at about three complete turns downwards from the position where the core is flush with the top of the coil former.

Remember that the filter is based on a nominal input impedance of 50 ohms so a 50 ohm impedance antenna or an antenna tuning unit will obtain the best results.

## Finally – the case

The case parts should now be soldered together – the important point here is that the sides must be at right-angles to the top. Again, use the single blob technique until you are satisfied with the angles – it is better if you do not solder right up to the front of the lid as the case overlaps the front to give a hooded effect, and if you solder right up to the front, the case may not fit as well.

## Layout of Printed Circuit Board

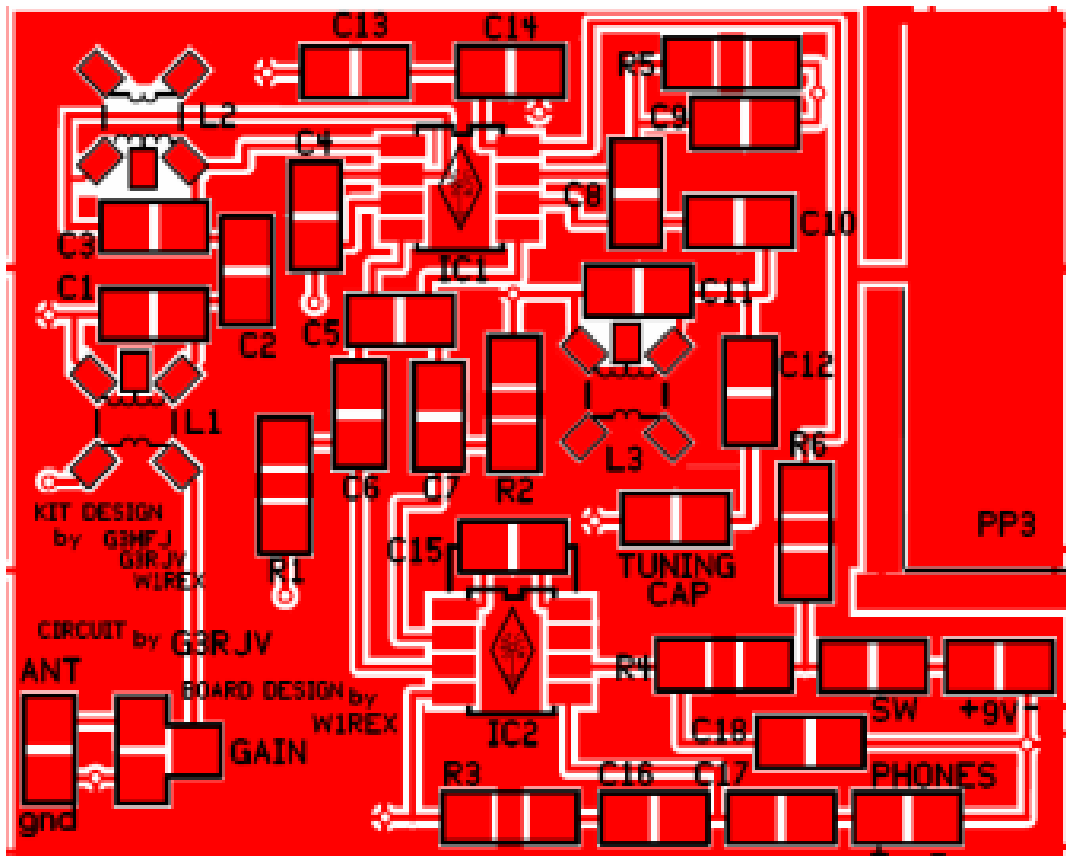

## Component List

### Resistors

	Value	Markings
R1	10k	brown black orange gold
R2	10k	brown black orange gold
R3	10	brown black black gold
R4	33	orange orange black gold
R5	33k	orange orange orange gold
R6	680	blue grey brown gold

### Capacitors

	Value	Markings
(All non-electrolytic capacitors are light brown unless another colour shown)		
C1	68pF	68
C2	10pF	10
C3	47pF	47
C4	4n7	472
C5	47n	473
C6	100nF	1042 or 104
C7	100nF	1042 or 104
C8	1nF	102
C9	1nF	102
C10	470pF	471 (yellow)
C11	22pF	22P (grey)
C12	1nF	102
C13	100nF	1042 or 104
C14	100uF	100uF 16V
C15	10uF	10uF 25V
C16	100nF	1042 or 104
C17	100uF	100uF 16V
C18	100uF	100uF 16V

### Inductors

L1	45u0L	Red
L2	45u0L	Red
L3	5u3L	Yellow

### Semiconductors

IC 1	SA612AN	Mixer/oscillator
IC 2	LM386N-1	Audio amplifier

\* an SA602 or SA612 may be supplied

### Other parts

VR 1	10k	RF Gain
VC 1	60pF polyvaricon	Tuning
Screws & washers	For tuning capacitor	
SW	miniature toggle switch	on/off switch
Skt 1	3.5mm stereo jack socket	Phones
Skt 2	Phono/RCA socket	Antenna
Batt clip	PP3 clip	
8 pin IC socket	x 2	
Knobs	15mm and 35mm	
Wire	3 colours of wire	
Battery	PP3	
2 off PCBs	Board/front/rear and case	
4 feet	Self adhesive feet	For the base

# Complete circuit diagram

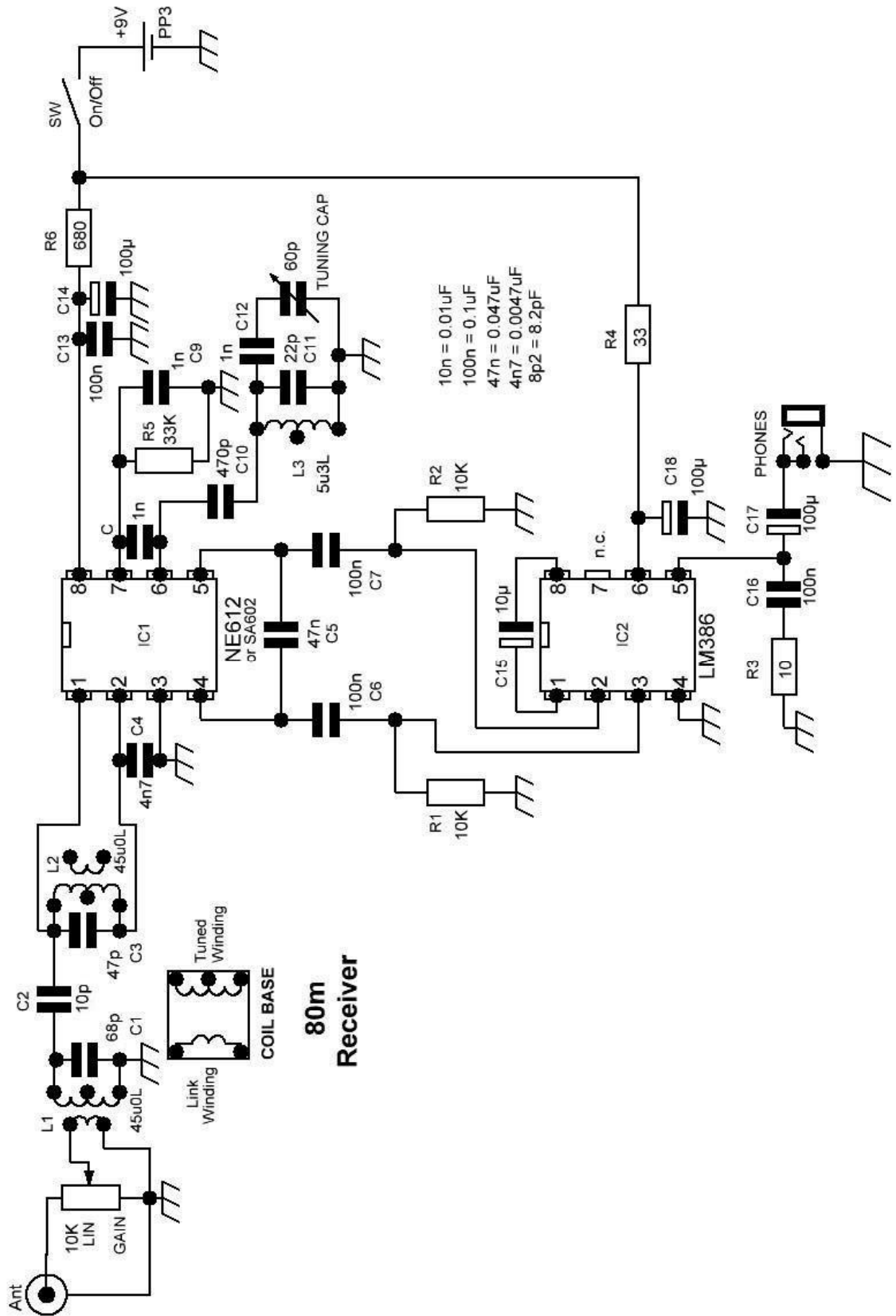

## Top view of completed receiver

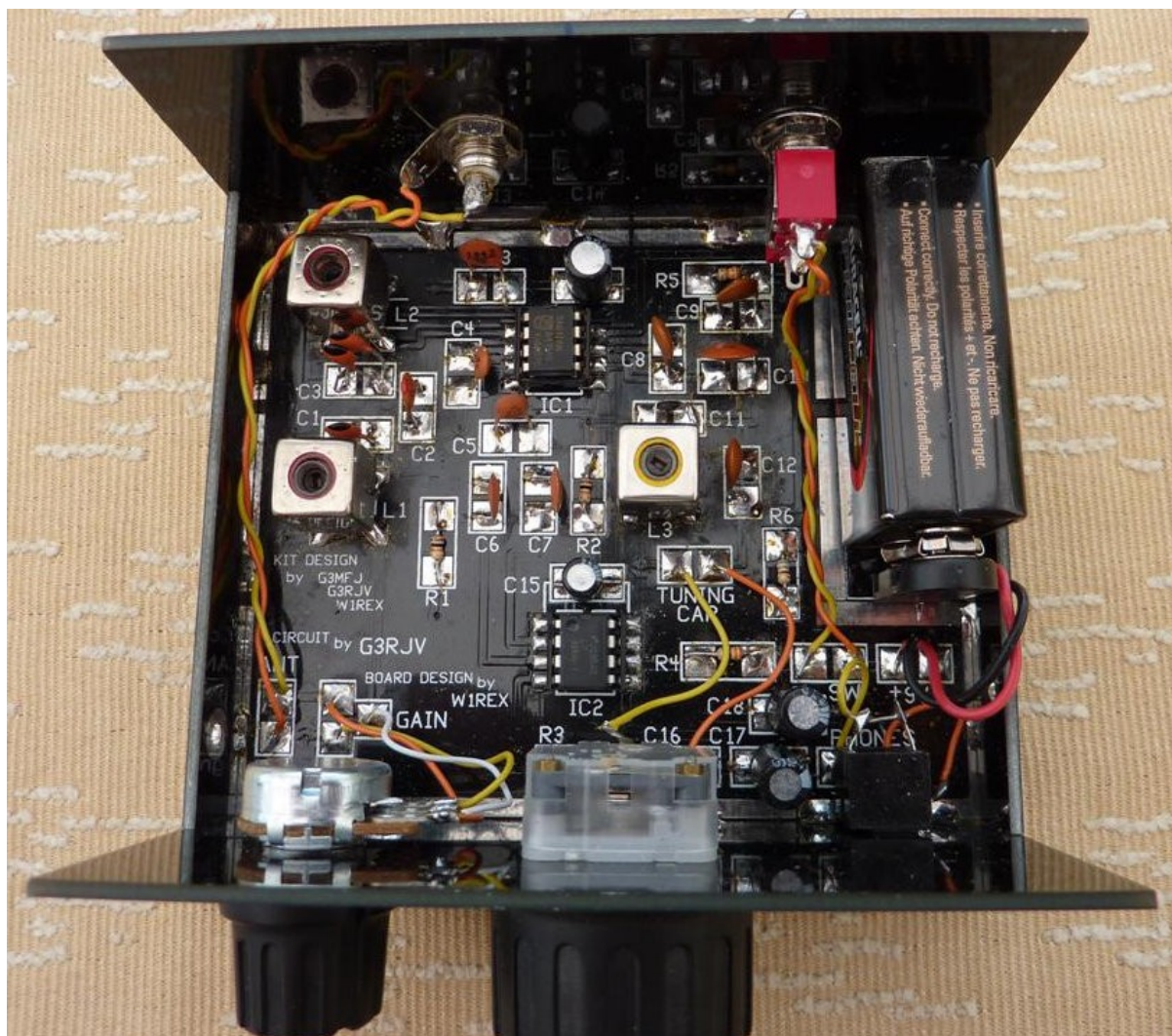

© G-QRP Club 2010, 11