



How it all works.

This is a group project and is designed to grow over the years. It should definitely not be seen as the work of a few or even an individual but contributed to by any club member who can type or draw.

It doesn't even need to be a thing of beauty as you can submit a hand sketch if you wish or something that you have used software to design.

The only stipulation is that it is your own work or you have permission from the copyright holder to submit it to the compiler, Tony G4WIF.

The submission must contain your name (and callsign if you have one), and if it is the work of someone else, then acknowledgement that it is being reproduced with their kind permission.

How to Submit.

Two file formats are proposed because the club does not have all the software that you might have. You can send a Microsoft Word File or convert your work to Portable Document format. All PC's are capable of this - and if you need advice then contact Tony G4WIF.

The club website will host an example Word template if you would like to use it but it isn't mandatory, just as long as the work carries credit to the author.

Finally ...

This document may not be sold and the club would very much appreciate that it is not hosted on any other website.

GQRP Component Data Book - Index



Useful Transistor pin-outs

OP-Amps

PIC Chips

Regulators

Mixers



Mervyn Stanton - G4CCQ

Handyman's Guide to Capacitors – Paul Harden NA5N

Popular Valve pin-outs – Bob Burns - G300U

TTL Pin-outs – Steve Harvey - N6QBQ

2N2222

PN2222

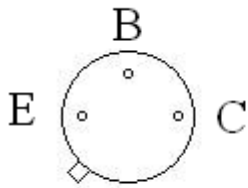

Underside View

2N3819

2N7000



Underside View

2N3904

2N3866

2N3906

2N4427

2N5109

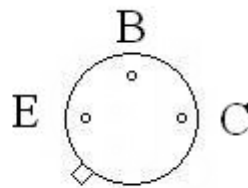

Underside View

Title: Useful Transistor pin-outs – version 2

Author: Mervyn G4CCQ
Page 1 of 2



GQRP Club
Datasheet

BC108

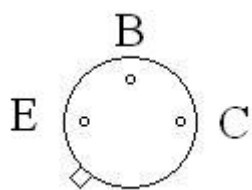

BC548

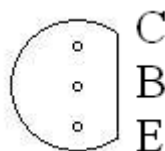

Underside View

BF961

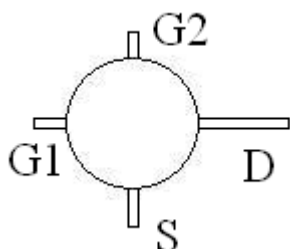

BFR90

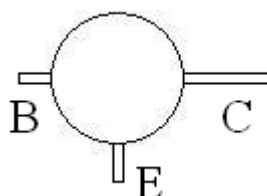

Top View

IRF510

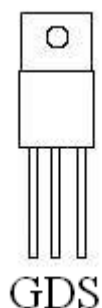

Top View

J304 J310



Underside View



LM386

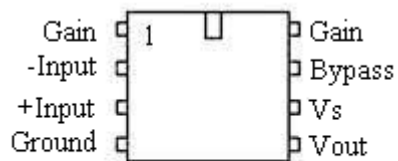

Top View

LM380 (14 pin version)

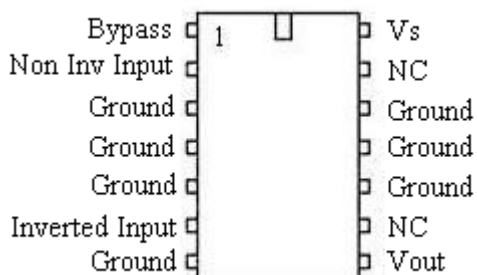

Top View

Note Pins 3, 4, 5, 10, 11, 12 are used as Heatsink pins

LM741

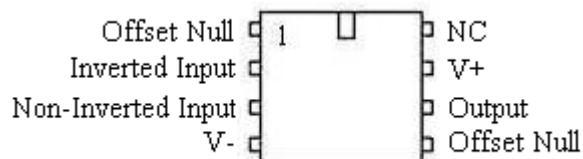

Top View



TL071

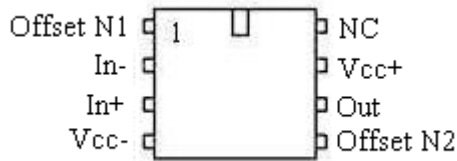

Top View

LM358

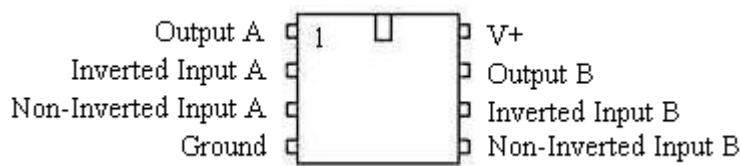

Top View

CA3240 (8 Pin Package)

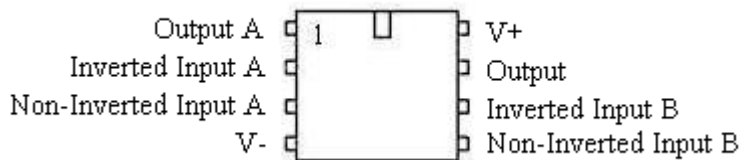

Top View

ML1350

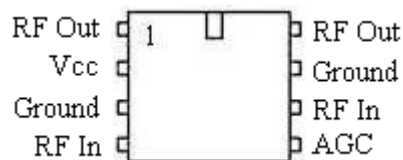

Top View



NE555

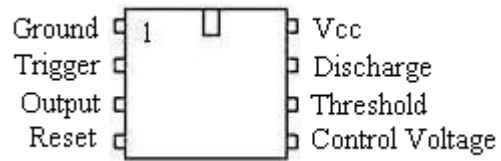

Top View

Title: Op-Amps, Amplifiers, Radio and Timer chips

Author: Mervyn Stanton G4CCQ
Page 3 of 3



GQRP Club
Datasheet

PIC16F84

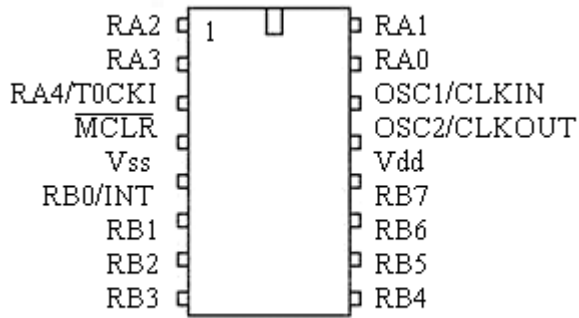

Top View

PIC16F628

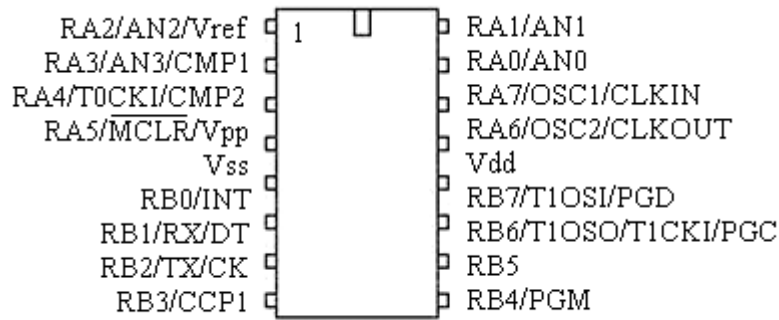

Top View

Title: PIC chips

Author: Mervyn Stanton G4CCQ
Page 1 of 1



GQR Club
Datasheet

LM340 (5V and 12V TO3 Style)

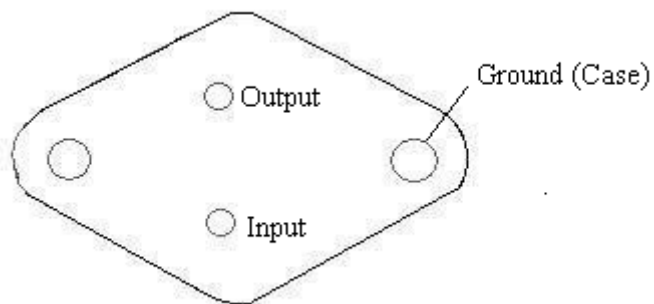

Underside View

LM7812 - LM7805 etc (TO220)

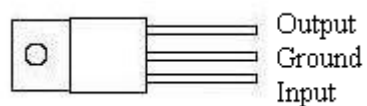

View from above

LM7905 etc

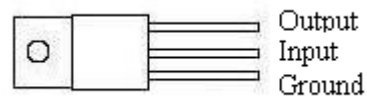

View from above

LM78L05 etc

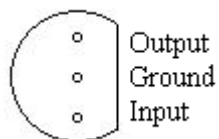

Underside View



LM79L05 etc

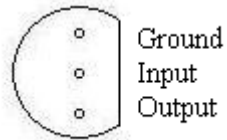

Underside View

LM317 (TO3 Style)

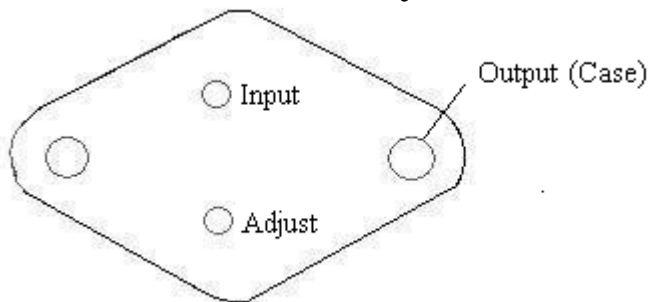

Underside View

LM317 (TO220 Style)

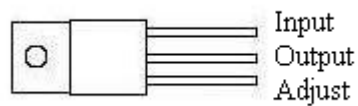

View from above



NE602

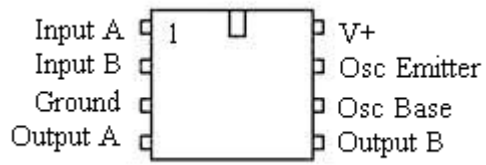

Top View

MC1496

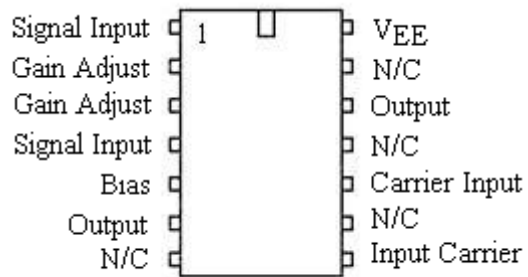

Top View

Title: Mixers

Author: Mervyn Stanton G4CCQ
Page 1 of 1



GQRP Club
Datasheet

The Handiman's Guide to CAPACITORS

Paul Harden, NA5N (NA5N@Rt66.com)

Capacitors comprise the *largest variety* of electronic components. There are many types of capacitors, great variations in their performance, many methods of packaging and marking, and dozens of major manufacturers, not to mention new types constantly being introduced with specific applications and performances. As a result, capacitors often cause lots of problems for homebrewers. Hopefully this article will take some of the mystery out of the myriad of capacitors available, plus present some of the classic "do's and don'ts."

PRINCIPAL CAPACITOR TYPES

There are many capacitor types, which usually refers to the material used for the electrodes, dielectric, and the packaging or sealing method. Here are some of the major capacitor types used by QRPers:

DISK CERAMIC CAPACITORS



Disk Ceramics consist of two metallic plates separated by a ceramic dielectric, whose area and spacing determines the capacitance. These caps are low cost and suitable for many applications. Their main disadvantage is high capacitance changes

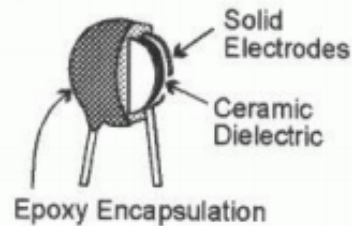

with temperature (high temperature coefficient), except for the "NPO" varieties that are temperature stable. These caps are the most commonly used for general purpose circuits, but the *non-NPO* types should be avoided in frequency determining circuits.

MONOLITHIC CERAMIC CAPACITORS



Alternating layers of electrodes and ceramic dielectric allow higher capacitances in physically smaller packages. Their characteristics are very similar to disk ceramics. They are encapsulated in epoxy to withstand insertion, soldering and

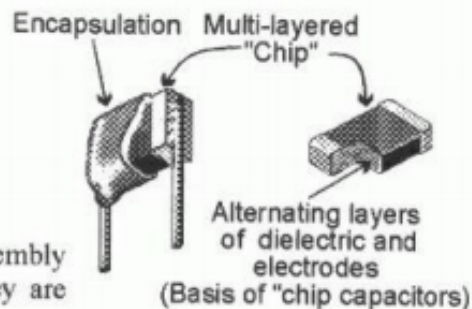

solvent cleaning by the automatic PCB assembly machines. Introduced for mass production, they are inexpensive and available from surplus dealers.

POLYESTER FILM CAPACITORS



Polyester Films use layers of metal and polyester (Mylar®) dielectric to make a wide range of capacitances in relatively small packages at low voltages. These have become the standard caps for DC applications. The "rolled" film layers cause high dissipation and capacitance vs. temperature problems, and should be used carefully in high frequency or high current applications.

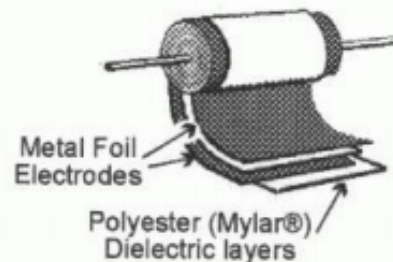

Title: Handyman's Guide to Capacitors

Author: Paul Harden NA5N
Page 1 of 6



GQRP Club
Datasheet

POLYPROPYLENE FILM CAPACITORS



Polypropylene Films use layers of metal and polypropylene dielectric films virtually identical to Polyester Film caps. The polypropylene, however, is a dielectric offering a higher breakdown voltage than polyester, and thus more suitable for high voltage applications, such as switching power supplies. They also have low loss factors and good capacitance stability making them a good choice for high frequency applications, including oscillators and other frequency sensitive circuits. The main disadvantages are a slightly higher cost, and larger physical sizes over other film dielectric capacitors.

SILVER MICA CAPACITORS

This is a type of capacitor known as *metalized film* capacitor, in that the electrodes are a metal deposited by a sputtering process onto the dielectric film. **Silver Mica's** use a *mica* film dielectric with a thin layer of deposited silver forming the electrodes. These are *very* stable capacitors for high frequency circuits and the preferred choice for VFO and oscillator circuits. The main disadvantage are their higher cost, low operating voltages, and sometimes hard to find from hobby vendors.

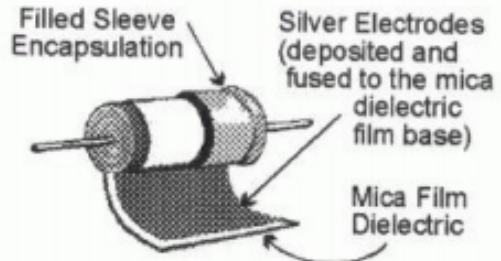

POLYCARBONATE FILM CAPACITORS

These capacitors have become the standard for high stability MIL-SPEC film dielectrics. Their very low dissipation and extreme temperature stability make them almost the ideal capacitor --*at a price!* They are very expensive capacitors and not available from the hobby vendors, but listed here in the event you have the opportunity to appropriate some!

ELECTROLYTIC CAPACITORS



Aluminum Electrolytics are the most common, inexpensive electrolytic available from all hobby vendors. They are made similar to the polyester films, using aluminum foil electrodes and a dielectric material rolled into layers to increase the effective plate area to form high capacitances in small packages. The aluminum foil is "wetted" with a chemical agent to assist in conduction and increases the dielectric properties when a DC voltage is applied. This wetting agent can dry out after long periods of no use, or exceeding the rated voltage, causing a breakdown of the dielectric and component failure (usually a short circuit between the terminals). This is why electrolytics are often found shorted in older equipment that has not been powered for years. This is seldom a problem with equipment that is periodically powered up. These inexpensive aluminum electrolytic caps are suitable in all QRP applications.

TANTALUM CAPACITORS



Tantalum's are a most unusual process that yields a high reliable electrolytic with a long life. Tantalum pentoxide powder is mixed with a manganese dioxide electrolyte and formed into a "pellet," forming *both* the dielectric and the positive electrode plate. Graphite or silver plating forms the negative plate. This "pellet" forms a *very large effective plate area*, and thus very high capacitances in very small packages. Both wet and dry electrolytes are used, and called *wet* or *dry* tantalums. There are few QRP applications where tantalum's would be a *must*, but if you have them -- use them! The chief disadvantages are higher cost due to the complicated manufacturing process, and ensuring you never reverse the polarity. A small positive voltage on the negative terminal can fuse the "pellet."

Title: Handyman's Guide to Capacitors

Author: Paul Harden NA5N
Page 2 of 6



GQRP Club
Datasheet

PRINCIPAL PACKAGING STYLES

In addition to the capacitor types (ceramic, metalized films, etc.), the *packaging style* is also important, and often required when ordering. The major capacitor packaging styles are shown below, which can also be used as an aid in identifying unknown capacitors.

CAPACITORS WITH RADIAL LEADS

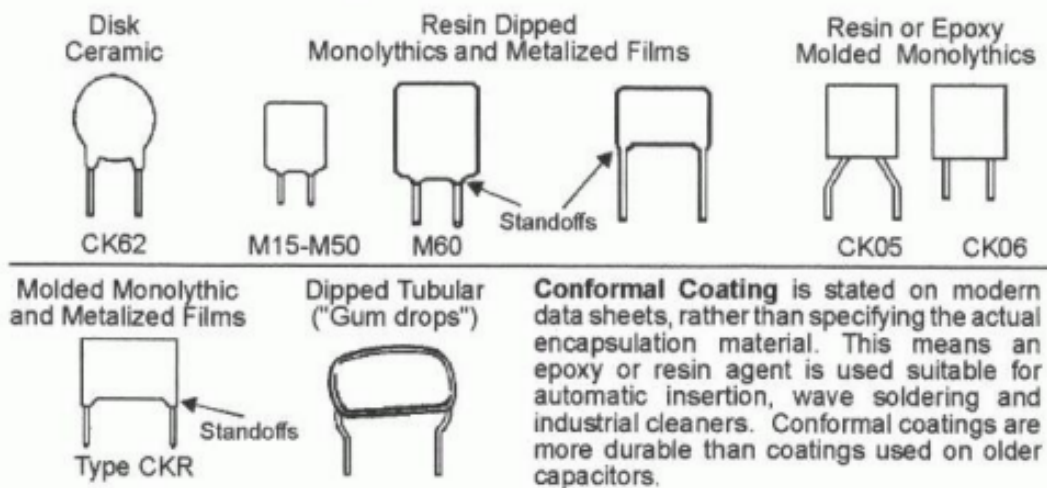

CAPACITORS WITH AXIAL LEADS

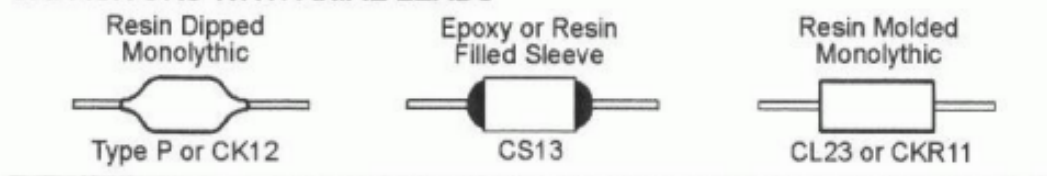

ORDERING/SPECIFYING CAPACITORS

When ordering capacitors, obviously the first concern is the capacitance, voltage rating and capacitor type needed. However, the *temperature coefficient* (TC) should be considered in frequency sensitive circuits (oscillators, VFO's, etc.) and the *dissipation factor* (DF) or *Q* when efficient energy transfer is needed (interstage coupling, active filters, etc.) or high peak-to-peak voltages (transmitter output filter caps).

TEMPERATURE COEFFICIENT

The **temperature coefficient (TC)** is the change in capacitance vs. a change in temperature. The ideal capacitor should have very little capacitance change with temperature, but as the charts show below, some capacitor types are far from ideal!

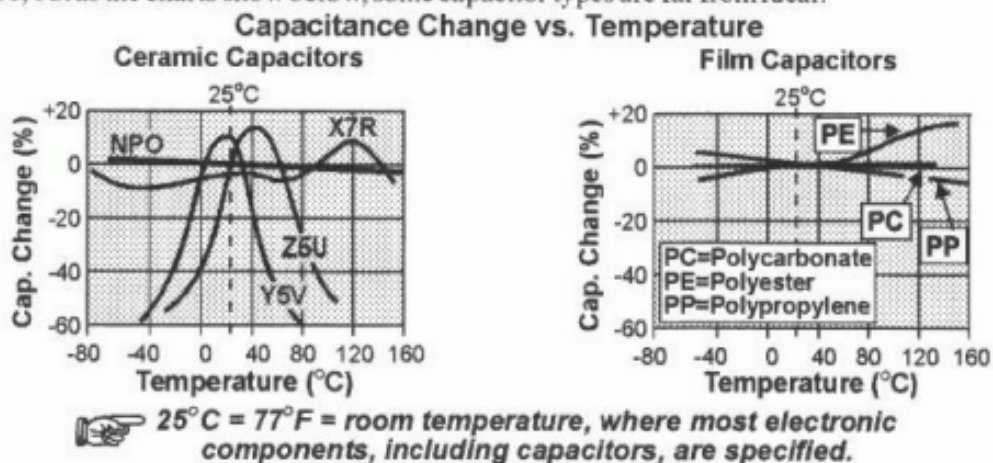

Title: Handyman's Guide to Capacitors

Author: Paul Harden NA5N
Page 3 of 6



GQRP Club
Datasheet

The most common ceramic/monolithic ceramics are **X7R**, **Z5U** and **Y5V**. The **Z5U** and **Y5V** have a large temperature coefficient (and a large dissipation factor -- see below) and should not be used in frequency critical circuits or for coupling between stages. They are suitable for other general purpose applications and for DC and bypassing caps.

X7R's are the next best with moderate capacitance change vs. temperature and suitable as a general purpose capacitor, and can be used in oscillator circuits where moderate drift is acceptable.

NP0 (or C0G) are those ceramics made with a temperature stable dielectric which exhibits very little capacitance change with temperature. NP0's (N-P-zero) are recommended for oscillators and frequency sensitive circuits.

FILM CAPACITORS, such as the polyester and polypropylene, have much better capacitance stability vs. temperature than the general purpose ceramics, as also shown in the charts. Polyester caps are quite stable until about 120F.

DISSIPATION FACTOR (DF)

The **Dissipation Factor (DF)** is the ratio of the energy dissipated (lost) to the energy stored in the capacitor. The DF is frequency sensitive and specified at a certain frequency, such as 1KHz (for ceramics). The **Quality Factor (Q)** is the ratio of the energy stored vs. the energy dissipated - or the opposite of the dissipation factor. Film capacitors are usually specified by their "Q" factor.

Capacitors used for coupling small signals between stages, in active filters, the shunt caps on crystal filter, or in the transmitter output filter, should use low DF caps. Most all poly-film caps and some monolithic ceramics meet this requirement. Old ceramic caps in your transmitter output filter should be replaced with a low DF capacitor type, as a high DF cap here can absorb a surprising amount of your output power, and us QRPers need to get as much of that power to the antenna we can!

Dissipation Factor vs. Frequency

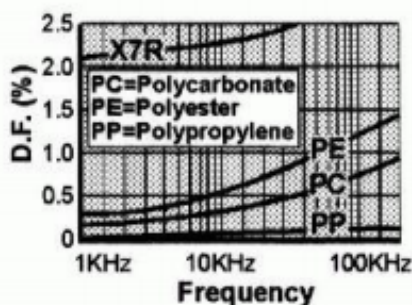

Dissipation Factor vs. Temperature

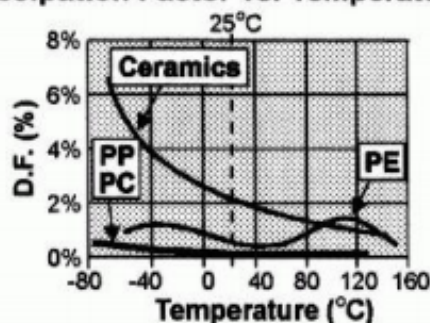

THE BOTTOM LINE

Ceramics that are not NP0 make good general purpose capacitors for bypass caps, etc. but should not be used for interstage coupling or in oscillators. When ordering new caps, I would recommend purchasing the monolithic ceramics for their lower cost.

NP0 Ceramics (especially the mono's) are a good choice for oscillator circuits.

Film Dielectrics are a good choice for a general purpose capacitor with low dissipation factors and good temperature characteristics. With their reasonably low cost, and about the same as ceramics, they would be today's preferred choice when purchasing new capacitors due to the low cost and better performance characteristics.

When ordering caps, look at the specifications carefully for TC and DF, along with the information and charts in this article, to make the best choice, performance vs. cost.

Title: Handyman's Guide to Capacitors

Author: Paul Harden NA5N
Page 4 of 6



GQRP Club
Datasheet

REFERENCE INFORMATION

The information on the following two pages is meant to be a general reference guide to assist in identifying capacitors, specifications and standard values.

CAPACITOR IDENTIFICATION

1. EIA IDENTIFICATION MARKINGS FOR CERAMICS

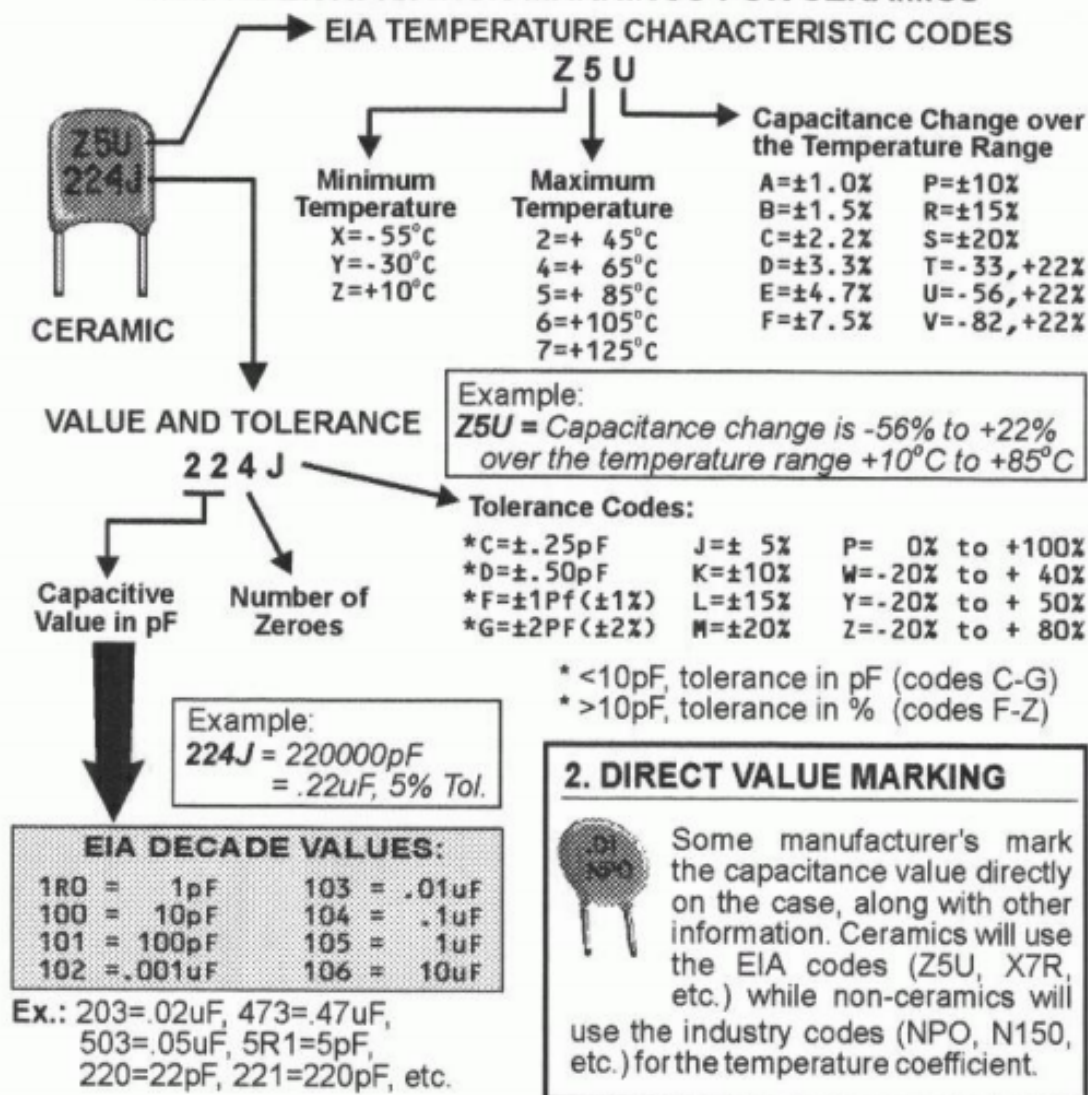

2. DIRECT VALUE MARKING



Some manufacturer's mark the capacitance value directly on the case, along with other information. Ceramics will use the EIA codes (Z5U, X7R, etc.) while non-ceramics will use the industry codes (NPO, N150, etc.) for the temperature coefficient.

3. INDUSTRY MARKINGS FOR MONOLYTHIC & FILM CAPACITORS

Non-ceramic capacitors use the EIA markings for the capacitance value and tolerance. However, these dielectrics, such as polyester or polypropylene, have a *linear* change in capacitance per °C and thus the temperature coefficients are expressed in parts-per-million (ppm)/°C or in %/°C. A few of the common industry (non-ceramic) and EIA (ceramic) markings are shown in the following table.



Temperature Coefficients (TC) Ceramics (EIA) & Films Dielectrics

EIA#	INDUSTRY	T.C. (ppm/°C)
C0G	NPO	0ppm/°C
S1G	N033	- 33ppm
U1G	N075	- 75ppm
P2G	N150	- 150ppm
S2H	N330	- 330ppm
U2J	N750	- 750ppm
P3K	N1500	-1500ppm

Title: Handyman's Guide to Capacitors

Author: Paul Harden NA5N
Page 5 of 6



GQR Club
Datasheet

4. COLOR CODING SCHEMES

Capacitor color coding schemes have all but disappeared except on some foreign made ceramics and dipped tantalums. The prevalent schemes are shown below.

CURRENT COLOR SCHEMES (STILL IN USE)

DIPPED TANTALUM CAPACITOR

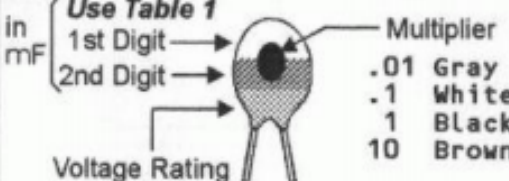

in mF Multiplier

Use Table 1

1st Digit →

2nd Digit →

Voltage Rating →

.01	Gray
.1	White
1	Black
10	Brown

3v	White	20v	Blue
6.3	Yellow	25v	Gray
10v	Black	35v	Pink
16v	Green		

MONOLYTHIC CAPACITOR

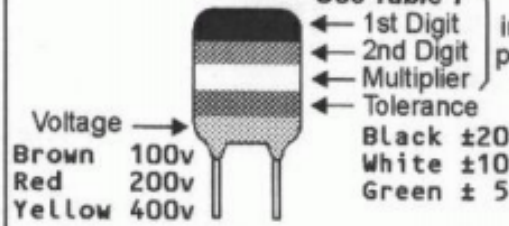

Use Table 1

1st Digit →

2nd Digit →

Multiplier →

Tolerance →

Voltage →

Black	±20%
White	±10%
Green	± 5%

Brown	100v
Red	200v
Yellow	400v

CAPACITOR COLOR CODES

Color	1st-2nd Digit	Multi-plier	% Tol.	T.C. ppm/°C
Black	0	1	±20%	- 0
Brown	1	10	± 1%	- 30
Red	2	100	± 2%	- 80
Orange	3	1K		-150
Yellow	4	10K		-220
Green	5	100K	± 5%	-330
Blue	6	1M		-470
Violet	7	--		-750
Gray	8	.01		+ 30
White	9	.1	±10%	+500

TABLE 1

Capacitance Values for all capacitor types

Temp. Coefficient and Tolerance for Ceramic/Monolythic types only

TUBULAR CERAMIC CAPACITOR

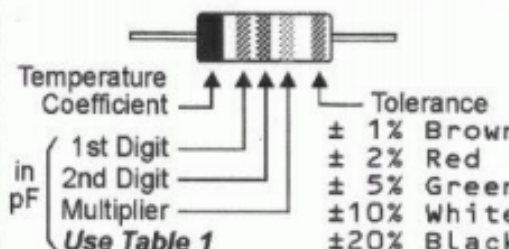

Temperature Coefficient →

1st Digit →

2nd Digit →

Multiplier →

Use Table 1

Tolerance →

± 1%	Brown
± 2%	Red
± 5%	Green
±10%	White
±20%	Black

STANDARD CAPACITOR VALUES

These are the EIA **standard capacitor values**. These are the values available from most vendors. Non-polarized run from 1pF to 1uF, while electrolytics are available from 0.1uF and higher (not all electrolytic values listed here).

1.0pF	10pF	100pF	.001uF	.01uF	.1uF	1.0uF	10uF
1.2pF	12pF	120pF	.0012uF	.012uF	.12uF	1.2uF	12uF
1.5pF	15pF	150pF	.0015uF	.015uF	.15uF	1.5uF	15uF
1.8pF	18pF	180pF	.0018uF	.018uF	.18uF	1.8uF	18uF
2.2pF	22pF	220pF	.0022uF	.022uF	.22uF	2.2uF	22uF
2.7pF	27pF	270pF	.0027uF	.027uF	.27uF	2.7uF	27uF
3.3pF	33pF	330pF	.0033uF	.033uF	.33uF	3.3uF	33uF
3.9pF	39pF	390pF	.0039uF	.039uF	.39uF	3.9uF	39uF
4.7pF	47pF	470pF	.0047uF	.047uF	.47uF	4.7uF	47uF
5.6pF	56pF	560pF	.0056uF	.056uF	.56uF	5.6uF	56uF
6.8pF	68pF	680pF	.0068uF	.068uF	.68uF	6.8uF	68uF

The capacitor information in this article was extracted from the *Data Book for Homebrewers and QRPers*, which contains data and information sheets on most all discrete components, hardware, IC's, etc. It is available for \$20 each

(which *includes* postage to US/VE addresses). Available from:

Quicksilver Printing
P.O. Box 757

Socorro, New Mexico 87801
(or info from: NA5N@Rt66.com)

Title: Handyman's Guide to Capacitors

Author: Paul Harden NA5N
Page 6 of 6



GQRP Club
Datasheet

Notes:

This list includes all valves featured in Sprat editions 1 – 177.

'All numeric' valve identifiers appear first followed by alpha-numeric identifiers, each sorted in ascending order.

Mazda Octal and International Octal valve bases are not mutually compatible due to minor differences in pin spacings.

All bases are shown as an underside view i.e. viewed from the pin end of the valve unless otherwise stated. A few valves are shown with an additional side view where it is appropriate.

A = anode, C = cathode, , G or G1 = control grid, G2 = screen grid, G3 = suppressor grid, H- = negative heater, H+ = positive heater, I.C. = internally connected, N.C. = not connected T.C. = top cap.

Internally connected pins should be left disconnected except for the VR series of gas regulator where they may be used to disconnect the circuit if the regulator is removed.

807



955



5763

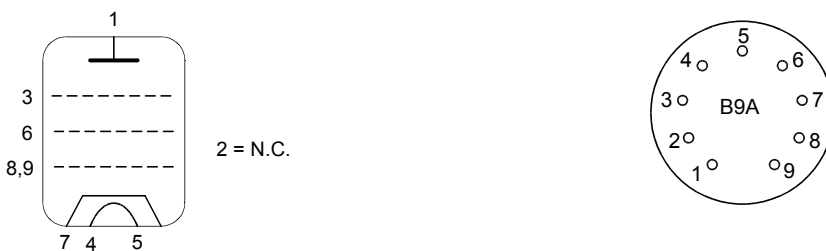

6146

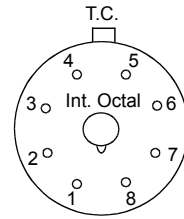
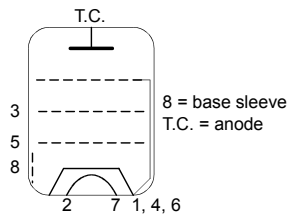

Pin 1 connected to internal shield, pin 8 connected to base shield.

7360

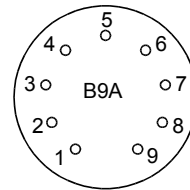
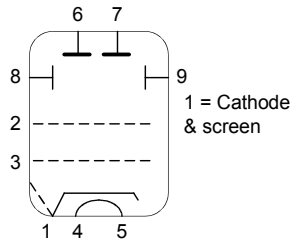

1J18B

Side view

Underside view

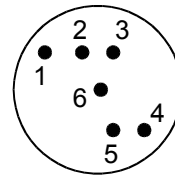
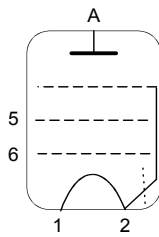

Pin 2 = heater -

1J24B

Side view

Underside view

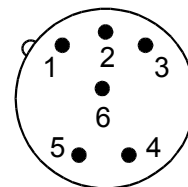
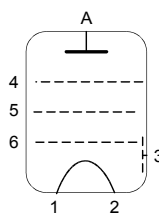

Pin 2 = heater -



1J29B

Side view

Underside view

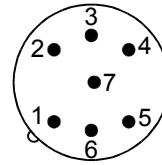
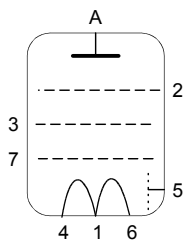

1P24B

Side view

Underside view

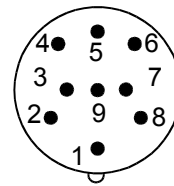
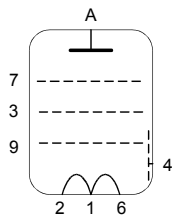

1S5

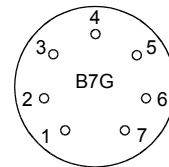
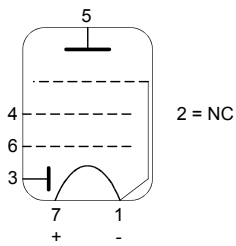

1SH24B

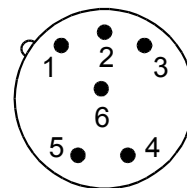
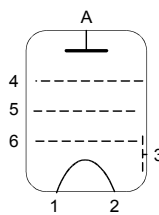

1T4 / DF91

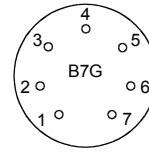
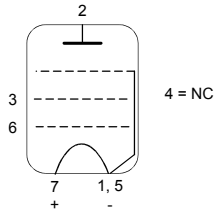

210RC / 610RC

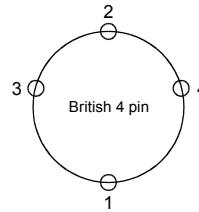
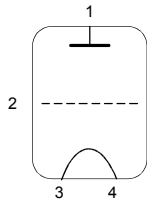

2E26

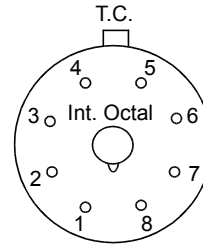
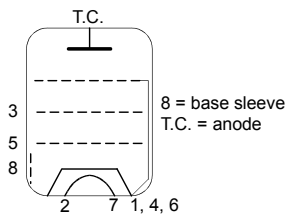

Pin 6 connected to internal shield, pin 8 connected to base shield.

3S4

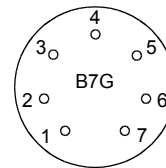
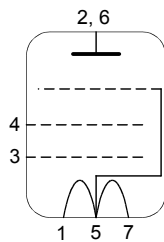

For parallel connected heaters, pin 5 is negative



5AR4 / GZ34

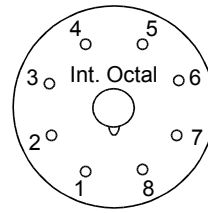
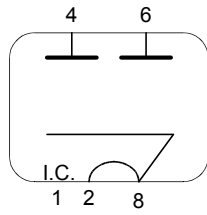

Pin 8 = heater and cathode

6AC7

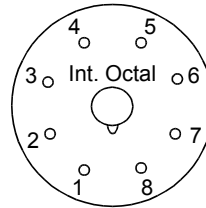
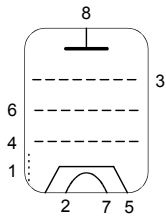

6AH6

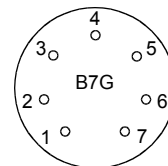
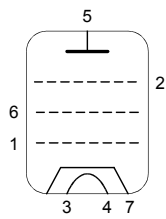

6AQ5 / EL90

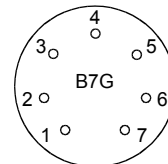
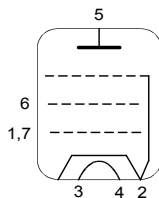

6AS6

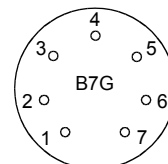
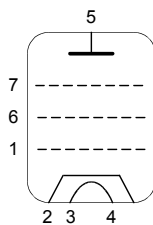

6AU6A / EF94

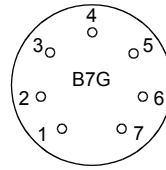
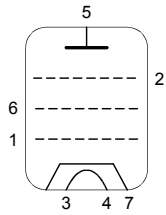

Pin 2 = G3 and internal screen

6BA6

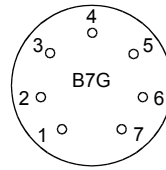
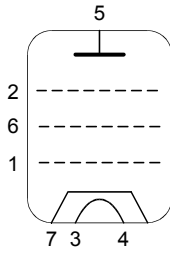

6BN6

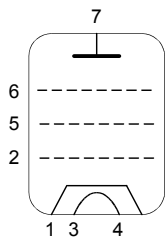

5 = Accelerator grid
6 = Quadrature grid

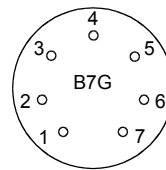

6BQ6

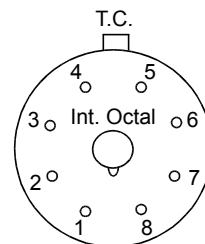
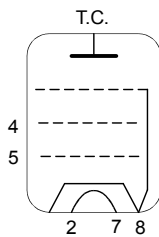

Pins 1 and 3 = N.C., 6 not fitted



6BQ7A

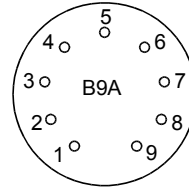
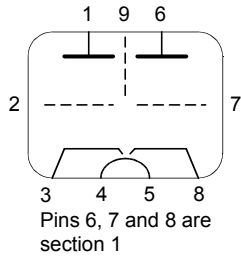

6BW6

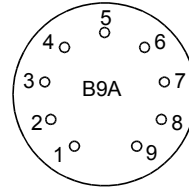
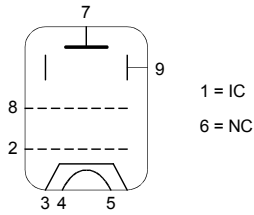

6CH6

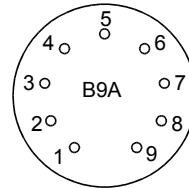
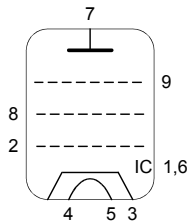

Pins 1 & 6 = I.C.

6CL6

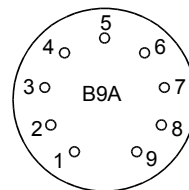
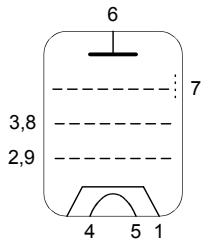

Pin 7 = G3 and internal shield



6CW4

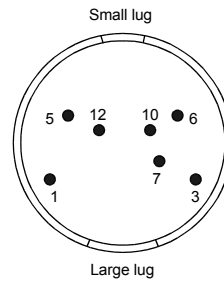
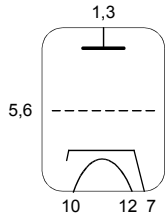

6F6 / 6K6 / 6L6 / 6V6 / 6W6 / 6Y6

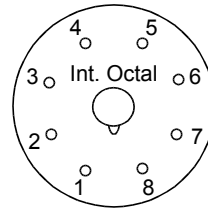
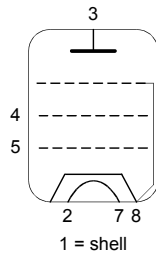

6H8C / 6SL7 / 6SN7

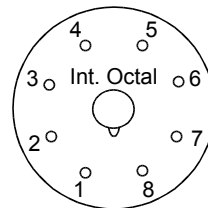
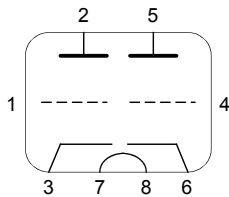

6JB6

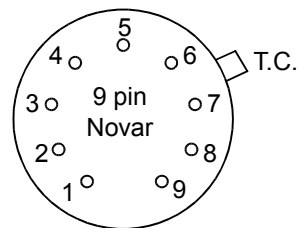
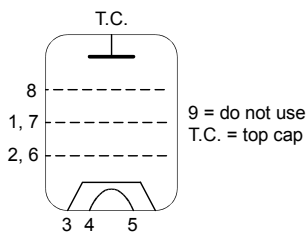

6JH8

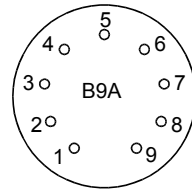
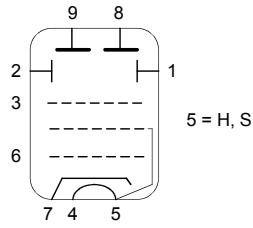

6K8

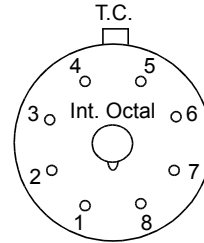
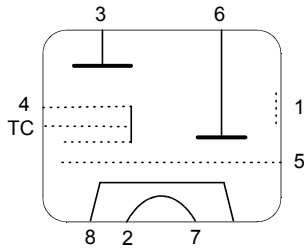

6SK7G / 6137

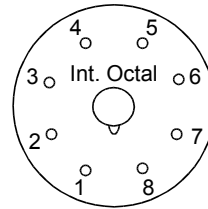
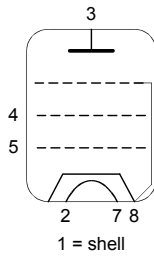

6X5

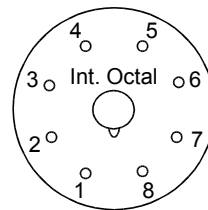
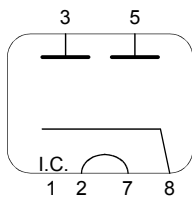

6X5: Pin 1 = Metal shell, 6X5G/GT pin 1 = N.C.



12AL8

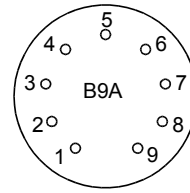
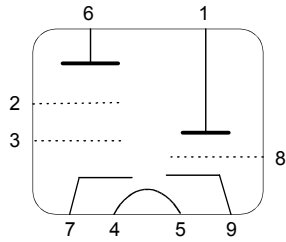

12AT7 / ECC81, 12AU7 / ECC82, 12AX7 / ECC83

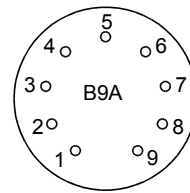
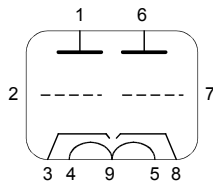

12BY7

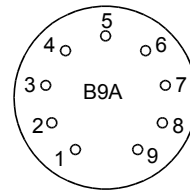
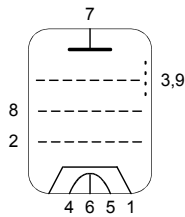

Pins 3 & 9 = G3 and internal screen, pin 6 = heater centre tap.

12K5

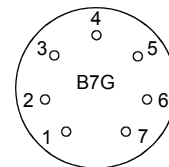
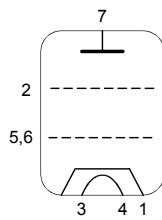

150B2

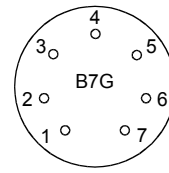
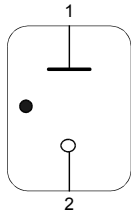

Pins 3, 4, 5, 6 & 7 = I.C.

ATP4 / V248A

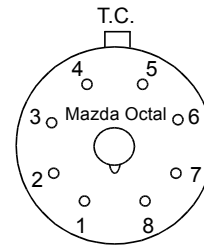
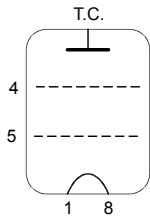

Pins 2, 3, 6 & 7 = N.C. Pin 1 is negative, pin 8 is positive.

DF33

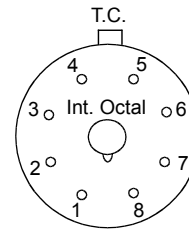
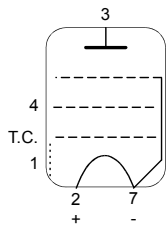

T.C. = G1. Pins 5 & 8 = N.C. Pin 6 not fitted.

E88CC

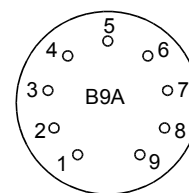
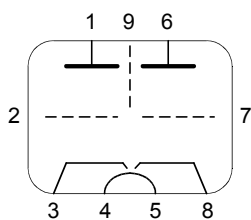

Pin 9 = internal screen



ECC85

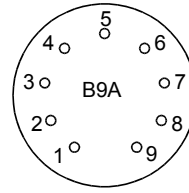
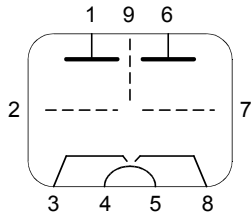

Pin 9 = internal screen

ECF80

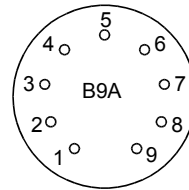
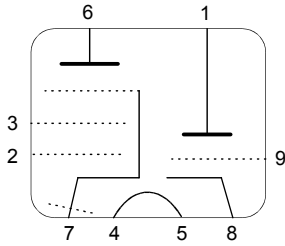

Pin 7 = cathode + G3 + internal screen

ECF82 / 6U8

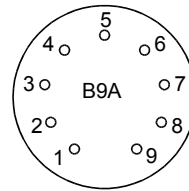
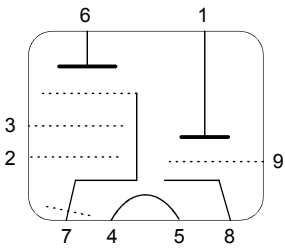

Pin 7 = cathode + G3 + internal screen

ECH42

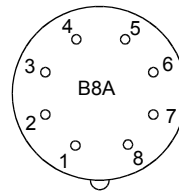
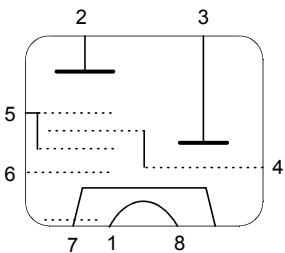

ECH81

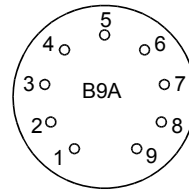
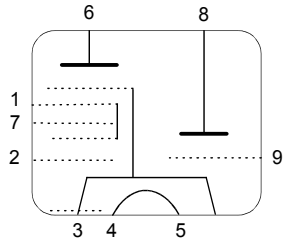

ECL80

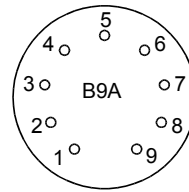
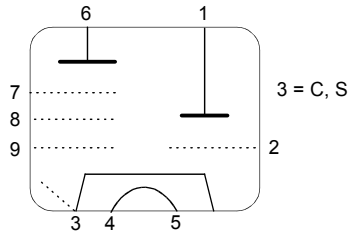

ECL82

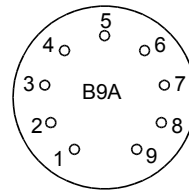
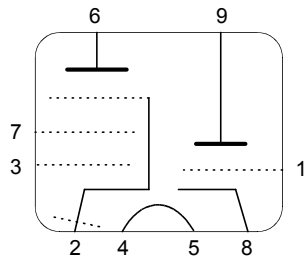

Pin 2 = cathode + G3 + internal screen

ECL86

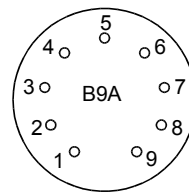
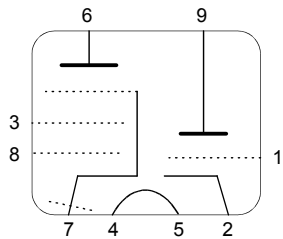

Pin 7 = cathode + G3 + internal screen



EF12



Pin 3 = cathode, G3 and metal screen

EF14



Pin 3 = metal casing

EF184



EF80



Pin 6 = internal screen



EF91 / 6AM6 / CV138

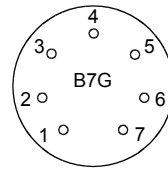
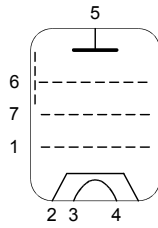

EF92

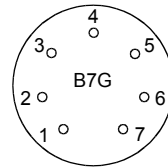
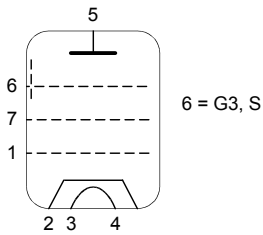

EF95 / 6AK5

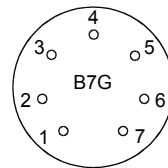
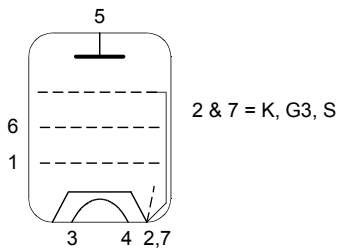

EL84

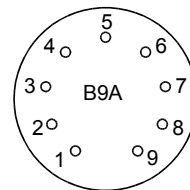
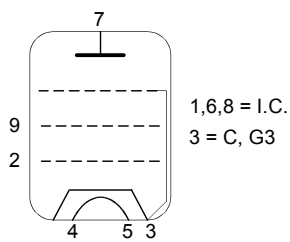

EL90

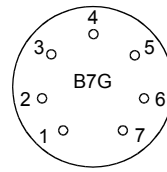
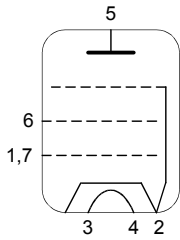

EL91

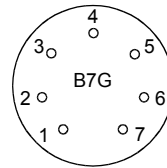
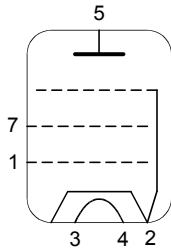

Pin 6 = N.C.

HL2K

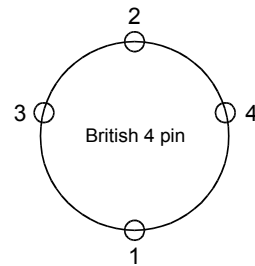
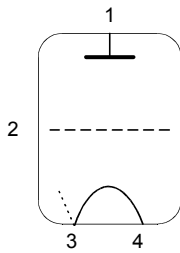

Pin 3 – heater and internal screen

OA2

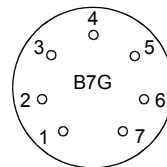
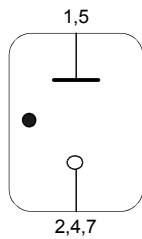

Pins 3 & 6 internally connected – do not use



PCL83

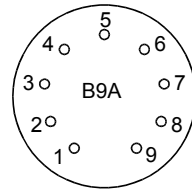
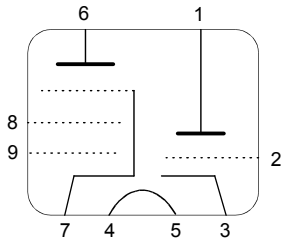

PM22

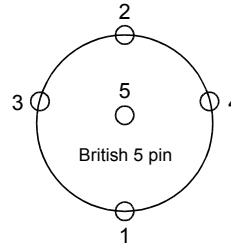
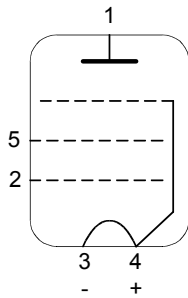

Pin 3 = heater +, pin 4 = heater – and G3

QQE03-12, 6360

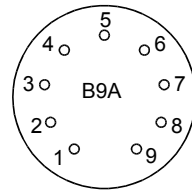
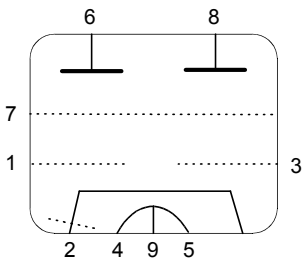

Pin 2 = cathode and internal screen, pin 9 = heater centre tap

QQZ06-40

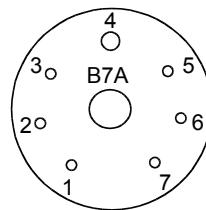
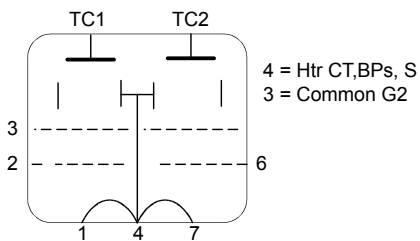

This valve has two anode pins at the top end of the envelope



VR75 / VR105 / VR150

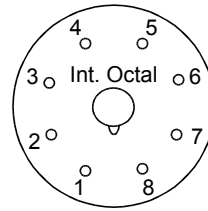
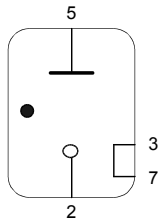

Pins 3 and 7 internally linked, pins 1 & 8 = no connection, pins 4 & 6 not fitted

XFY43

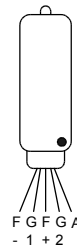
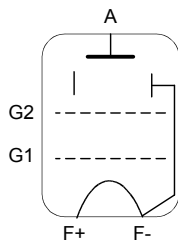

B5A (spot = pin 1)



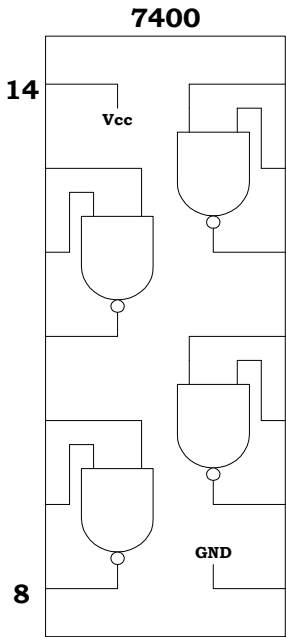

QUAD NAND

7404/7414

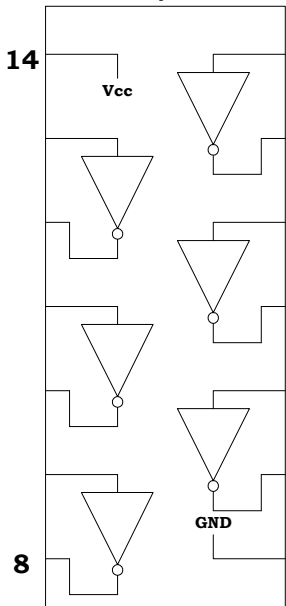

HEX INVERTER

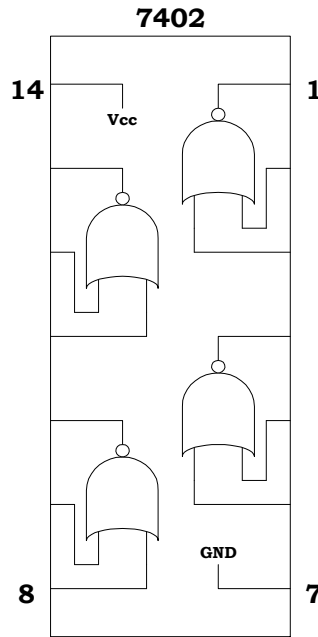

QUAD NOR

7474

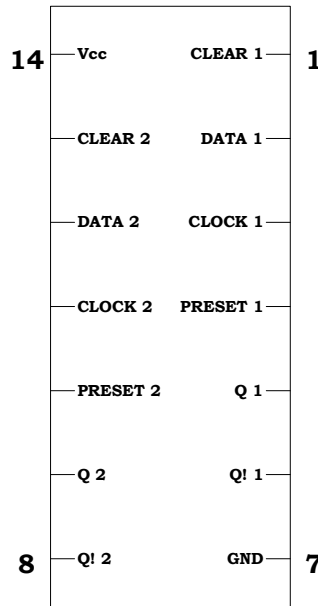

DUAL D FLIP-FLOP

View from below.

Title: TTL IC'S FOR RF OSCILLATORS AND FREQUENCY DIVISION, "DEAD-BUG" VIEW

Author: S. HARVEY N6QBQ



GQRP Club
Datasheet

The GQRP Club



If you have found this book useful....

.. please consider joining the GQRP club (if you are not already a member). The subscription rates are published on the club website at www.gqrp.com and are lower than you might expect. This is because the club is run entirely by volunteers so your subscription goes a long way.

We have a quarterly magazine called "Sprat" and a club sales manager who can provide components to members at a much reduced price. Plus we have other items for sales such as DVD's and books.

We offer a club QSL bureau, technical advice and awards to work towards for achievement in QRP.

Our membership secretary can be contacted with any enquiries regarding joining the club and we also have representatives in many countries if you prefer dealing with someone local.

Contact details for everyone involved in running the club can be found on the club website (www.gqrp.com).

Finally ...

Thank you to all the contributors of this component data book.